



AHU-KIT SERVICE MANUAL



**T1/R410A/50-60Hz
(GC201505 - I)**

Preface

For correct installation and operation, please read all instructions carefully. Before reading the instructions, please be aware of the following items:

- (1) For the safe operation of this unit, please read and follow the instructions carefully.
- (2) During operation, total capacity of indoor units should not exceed the total capacity of outdoor units. Otherwise, poor effect of cooling or heating may result.
- (3) Direct operators or maintainers should well keep this manual.
- (4) If this unit fails to operate normally, please contact our service center as soon as possible and provide the following information:
 - Content on the nameplate (model number, cooling capacity, production code, ex-factory date).
 - Malfunction details (before and after the malfunction occurs).
- (5) Each unit has been strictly tested and proved to be qualified before ex-factory. In order to prevent units from being damaged or operating normally because of improper disassembly, please do not disassemble the unit by yourself. If you need to disassemble and check units, please contact our service center. We will send specialists to guide the disassembly.
- (6) Do only use this system in combination with a field supplied air handling unit. Do not connect this system to other appliances.
- (7) The outdoor unit and the air handling unit can both influence the overall performance of the unit, please be sure to select appropriate outdoor unit, air handling unit and AHU-KIT unit according to actually apply requirements.
- (8) This equipment is not designed for year-round cooling applications with low indoor humidity conditions, such as Electronic Data Processing rooms.
- (9) All graphics in this manual is only for your reference. For sales or production reasons, these graphics are subject to change by manufacturer without prior notice.

User Notice

This appliance can be used by children aged from 8 years and above and persons with reduced physical, sensory or mental capabilities or lack of experience and knowledge if they have been given supervision or instruction concerning use of the appliance in a safe way and understand the hazards involved. Children shall not play with the appliance. Cleaning and user maintenance shall not be made by children without supervision.

Disposal	
	This marking indicates that this product should not be disposed with other household wastes throughout the EU. To prevent possible harm to the environment or human health from uncontrolled waste disposal, recycle it responsibly to promote the sustainable reuse of material resources. To return your used device, please use the return and collection systems or contact the retailer where the product was purchased. They can take this product for environmental safe recycling.

Contents

Chapter One: Product Introduction	1
1. Product Specification.....	1
1.1 Product Profile.....	1
1.2 Key Parts' Name	1
2. Basic Principle.....	1
2.1 Sketch Map of System Connection.....	1
3. Basic Parameters	2
Chapter Two: Control Part	5
1.DISPLAY.....	5
1.1 LCD OF WIRED CONTROLLER	5
1.2 LCD DISPLAY INSTRUCTION.....	6
2.BUTTONS	8
2.1 BUTTON GRAPHICS	8
2.2 FUNCTION INSTRUCTION OF BUTTONS	8
Chapter Three: Installation Parts	9
1. Preparations for Installation	9
1.1 Before Installation	9
1.2 Standard Fittings	9
1.3 Selecting the Air Handling Unit	9
1.4 Selecting the AHU-KIT Unit.....	10
1.5 Location for Installation.....	11
1.6 Requirements for Communication Wire	12
1.7 Wiring Requirements	13
2. Installation Instructions	14
2.1 Unit Dimensions and Maintenance Space.....	14
2.2 Piping Installation	16
2.3 EXV Installation	18
2.4 Installation of the Control Box.....	19
2.5 Installation of the Thermistors	20
2.6 Installation of the EXV Cable	22
2.7 Installation of Wired Controller	23
3. Wire Connection	24
3.1 Connect Cables and Terminals of Wiring Board.....	24
3.2 Power Cord Connection	25
3.3 Connection of Communication Wire between Indoor Unit and Outdoor Unit (or Indoor Unit)	25
3.4 Connect Communication Wire of Wired Controller.....	26
3.5 Illuminate for Connection of Wired Controller and Indoor Units (AHU-KIT) Network.....	26
Chapter Four: Debugging Operation	28
1. Before Operation	28
2. Test Operation	28
Chapter Five: Maintenance Part	29
1. Table of Error Codes for Indoor Unit	29
2. Troubleshooting.....	30
3. Routine Maintenance	31
3.1 Maintenance Before the Seasonal Use.....	31
3.2 Maintenance After the Seasonal Use	31
3.3 Disposal Requirements.....	31

Chapter One: Product Introduction

1. Product Specification

1.1 Product Profile

AHU-KIT is an air conditioning product developed by Gree, which is used for connecting “outdoor unit of VRF” and “combine unit”, making the “outdoor unit of VRF” as the cold source and heat source. Each AHU-KIT includes an electronic expansion valve box and a control box. This product is mainly applicable for business building, restaurant, supermarket, cinema, exhibition center, gymnasium, shopping mall, hotel, office building and big/medium scale public building.

1.2 Key Parts' Name

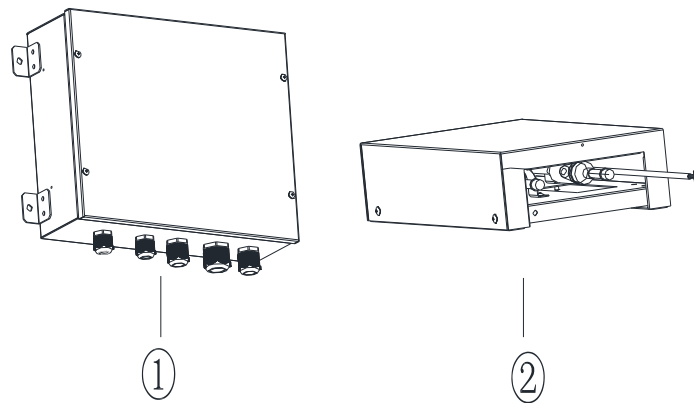

NO.	①	②
Name	Control box	Electronic expansion valve box

2. Basic Principle

2.1 Sketch Map of System Connection

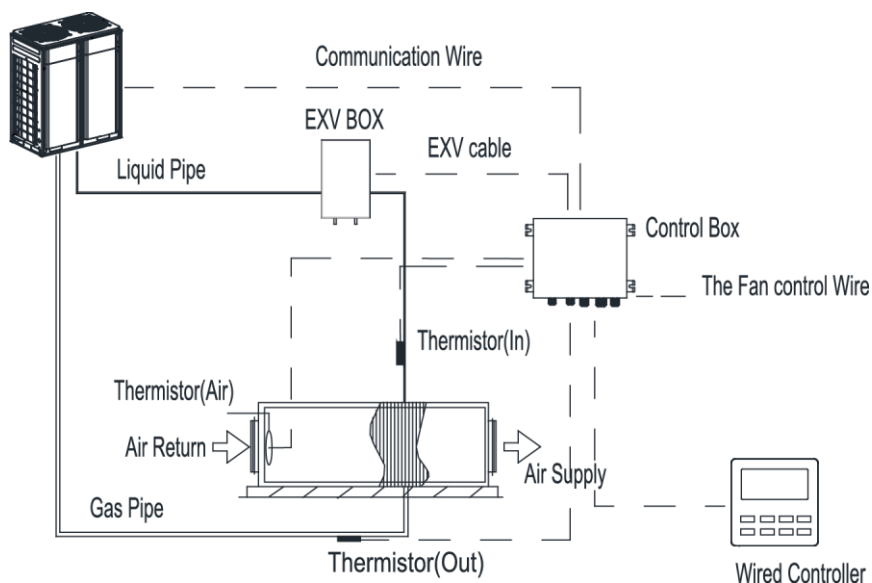

3. Basic Parameters

Model			GMV-N140U/A-T	GMV-N280U/A-T	GMV-N560U/A-T
Product Code			CN750N0030	CN750N0020	CN750N0010
Power		V/Ph/Hz	220~240/1/50 & 208~230/1/60		
Defaulted capacity of ex-factory	Cooling	kW	14	28	56
	Heating	kW	16	31.5	62.5
Adjustable capacity	Cooling	kW	9/11.2/14	22.4/28	45/50.4/56
	Heating	kW	10/12.5/16	25/31.5	50.0/56.5/62.5
Power		W	5	5	5
Size of connection pipe	Liquid pipe	mm	Φ9.52	Φ9.52	Φ12.7/Φ15.9/Φ15.9
	Gas pipe	mm	Φ15.9	Φ19.05/Φ22.2	Φ28.6
Connection method		—	Brazing Connection	Brazing Connection	Brazing Connection
Outline dimension (W × D × H)	Electronic expansion valve box	mm	203 × 326 × 85	203 × 326 × 85	246 × 500 × 120
	Control box	mm	334 × 284 × 111	334 × 284 × 111	334 × 284 × 111
Packing size (W × D × H)		mm	539 × 461 × 247	539 × 461 × 247	759 × 645 × 180
Net weight/gross weight		kg	8.6/11.5	8.6/11.5	11.8/15.5
Loading	40'GP	set	981	981	702
	40'HQ	set	1090	1090	756

Note:

- ① The parameters of the unit is subject to changed without prior notice due to improvement product. Please refer to the nameplate.
- ② Combination method of the unit: one-to-one, one-to-more, and mixed connection. One-to-one for 560 model; mixed connection and one-to-more for 140 model and 280 model.

(1) Below models can be connection to the same outdoor unit syste with the indoor unit of general VRF unit

AHU-KITmode	Model of outdoor unit
GMV-N140U/A-T	Can connect to modular outdoor unit of GMV-**WM/* series. The total capacity for AHU and the indoor unit of general air conditioenr should be 50%~100% of capacity of outdoor unit. The capacity of connected AHU can't be more than 30% of the outdoor unit. AHU-KIT can be used independently. The total capacity of connected AHU should be 50%~100% of capacity of outdoor unit.
GMV-N280U/A-T	

Note: When connecting AHU-KIT with the indoor unit of VRF unit, it must comply with the capacity requirement. The capacity of AHU can be more than 30% of capacity of outdoor unit and the capacity of indoor unit should be within 50%~100%. Otherwise, it may affect the operation, or even damage the unit.

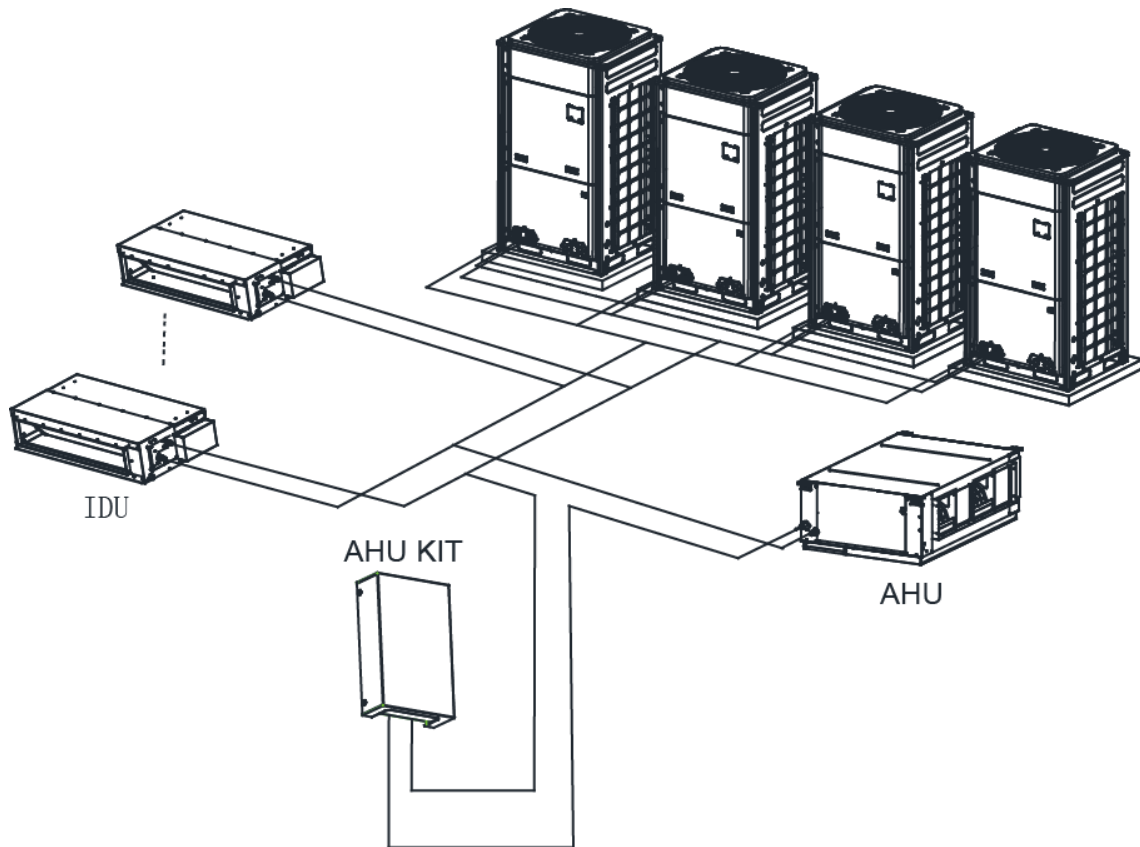

Sketch map for the connection of AHU-KIT and indoor unit of general VRF unit

(2) AHU-KIT in below table can only be connected by the fixed combination method

AHU-KIT model	Model of outdoor unit
GMV-N140U/A-T	GMV-140WL/A-T、GMV-140WL/A-X
GMV-N280U/A-T	GMV-280WM/*
GMV-N560U/A-T	GMV-280WM/* × 2sets

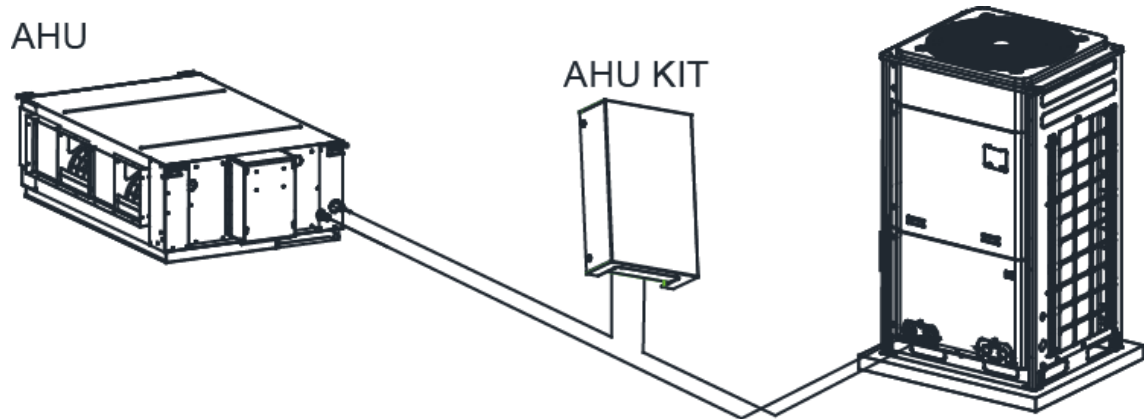

Sketch map for the connection of GMV-N140U/A-T and GMV-N280U/A-T

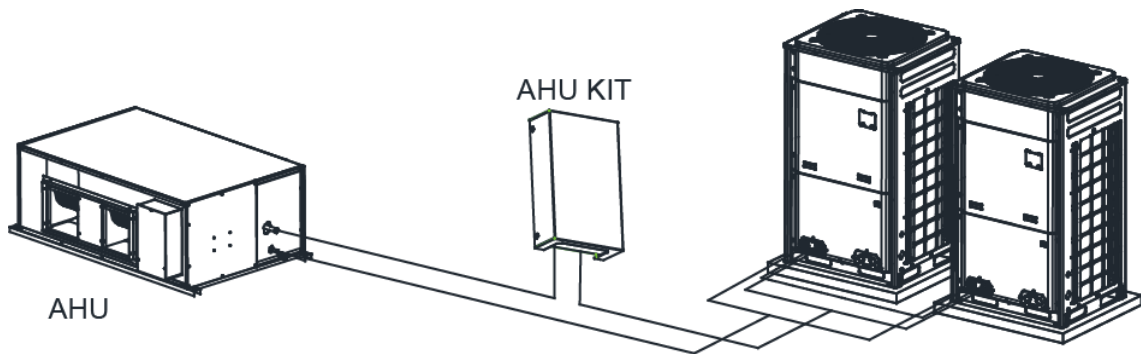

Sketch map for the connection of GMV-N560U/A-T

Chapter Two: Control Part

1.DISPLAY



Fig. 1.1 Appearance of wired controller

1.1 LCD OF WIRED CONTROLLER

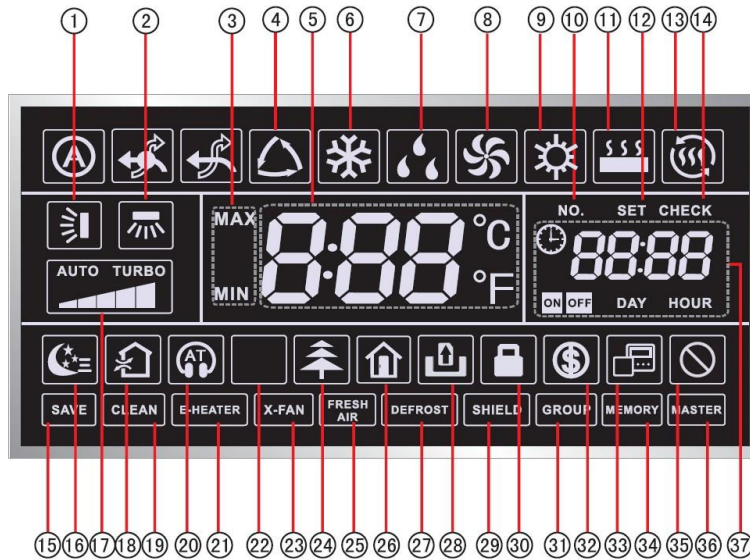







































Fig. 1.2 LCD graphics of wired controller

1.2 LCD DISPLAY INSTRUCTION

Table 1.1 LCD display instruction

No.	Symbols	Instructions
1		Up and down swing function
2		Left and right swing function
3		It's valid under Save mode and displays during setting process. Temperature lower limit for Cooling: Limit the minimum temperature value under Cooling or Dry mode. Temperature upper limit for Heating: Limit the maximum temperature value under Heating, Space Heating or 3D Heating mode.
4		Auto mode (Under Auto mode, the indoor units will automatically select their operating mode as per the temperature change so as to make the ambient comfortable.)
5		It shows the setting temperature value (In case the wired controller is controlling a Fresh Air Indoor Unit, then the temperature zone will display FAP)
6		Cooling mode
7		Dry mode
8		Fan mode
9		Heating mode
10		When inquiring or setting project number of indoor unit, it displays "NO." icon
11		Floor Heating mode (When Heating and Floor Heating simultaneously shows up, it indicates 3D Heating is activated.)
12		Display "SET" icon under parameter setting interface
13		Space Heating mode
14		Display "CHECK" icon under parameter view interface
15		Outdoor unit operates under Save mode/upper limit of system capacitor less 100%/remote Save status
16		Sleep status
17		Current set fan speed (including auto, low speed, medium-low speed, medium speed, medium-high speed, high speed and turbo seven status)
18		Air status, Indoor unit optional function

No.	Symbols	Instructions
19		Remind to clean the filter
20		Quiet status (including Quiet and Auto Quiet two status)
21		Allow auxiliary electric heating On icon
22		Light On/Off function
23		X-fan function
24		Health function, Indoor unit optional function
25		Reserved function
26		Out function
27		Outdoor unit defrosting status
28		Gate-control function
29		Shielding status
30		Child Lock status
31		One wired controller controls multiple indoor units
32		Save status of indoor unit
33		It indicates the current wired controller is the slave wired controller (address of wired controller is 02)
34		Memory status (The indoor unit resumes the original setting state after power failure and then power recovery)
35		Invalid operation
36		Current wired controller connects master indoor unit
37		Timer zone: Display system clock and timer status

2.BUTTONS

2.1 BUTTON GRAPHICS

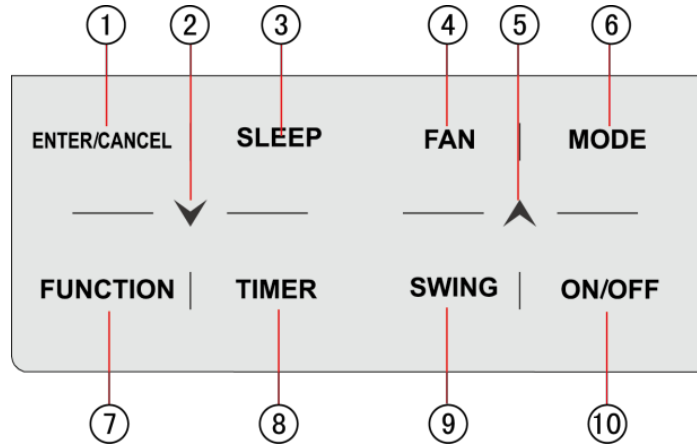

Fig. 2.1 Button graphics

2.2 FUNCTION INSTRUCTION OF BUTTONS

Table 2.1 Function instruction of buttons

No.	Buttons	Instructions
1	ENTER/CANCEL	Select and cancel function
2	▼	(1) Set operating temperature of indoor unit (2) Set Timer
5	▲	(3) Switch Quiet mode, Air grade, Clean grade, set upper and lower temperature limit under Save mode (4) Set and inquiry parameter
3	SLEEP	Set Sleep mode
4	FAN	Switch among auto, low speed, low-medium speed, medium speed, medium-high speed, high speed and turbo status
6	MODE	Switch Auto, Cooling, Dry, Fan, Heating, Floor Heating, 3D Heating and Space Heating modes for indoor unit. (Note: The Floor Heating, 3D Heating and Space Heating function icon will show up when the unit has those functions.)
7	FUNCTION	Switch among Air, Quiet, Light, Health, Out, Save, Clean, E-heater and X-fan functions.
8	TIMER	Timer setting
9	SWING	Set up and down swing status
10	ON/OFF	Indoor unit On/Off
2+5	▲+▼	Simultaneously press “▲” and “▼” for 5s to enter or cancel the Child Lock function.

Chapter Three: Installation Parts

1. Preparations for Installation

1.1 Before Installation

△ Notes: Product graphics are only for reference. Please refer to actual products.

Unspecified measure unit is mm.

(1) This equipment is designed for R410A system, and the designed working pressure is 4.2 MPa or 42 bar.

(2) Precautions for R410A:

The refrigerant requires strict cautions for keeping the system clean, dry and tight.

—Clean and dry: Foreign materials (including mineral oils or moisture) should be prevented from getting mixed into the system.

—Tight: Read this manual carefully and follow these procedures correctly.

Since R410A is a mixed refrigerant, the required additional refrigerant must be charged in its liquid state. (If the refrigerant is in state of gas, its composition changes and the system will not work properly).

The connected air handling units must have heat exchangers designed exclusively for R410A.

(3) Never use this appliance under inflammable and explosive gas.

(4) For the following items, take special care during construction and check after installation is finished:







Tick √ when checked
<input type="checkbox"/> Are the thermistors fixed firmly? Thermistor may come loose.
<input type="checkbox"/> Is the capacity code setted correctly? The performance of system may not achieve it's requirement.
<input type="checkbox"/> Is the control box fixed firmly? The unit may drop, vibrate or make noise.
<input type="checkbox"/> Do electrical connections comply with specifications? The unit may malfunction or components may burn out.
<input type="checkbox"/> Are wiring and piping correct? The unit may malfunction or components may burn out.
<input type="checkbox"/> Is the unit safely grounded? Dangerous at electric leakage.

1.2 Standard Fittings

Please use the supplied standard fittings listed below as instructed.

1.3 Selecting the Air Handling Unit

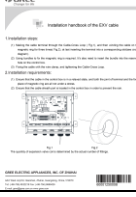
Please use the supplied standard fittings listed below as instructed.

No.	Name	Appearance	Quantity
1	Magnetic ring		1-2
2	Swell screw		4
3	Self-tapping screw		4
4	Bundle		1
5	Operating Instruction Manual		1
6	Operating Instruction Manual (Unitary Page)		1
7	Wired controller		1

Select the air handling unit according to the technical data and limitations mentioned in the following table. Lifetime of the outdoor unit, operation range or operation reliability may be influenced if you neglect these limitations.

Model	capacity (kW)	Allowable internal volume of heat exchanger (dm ³)		Allowable capacity of heat exchanger (kW)		Suggested air volume (m ³ /h)
		Minimum	Maximum	Minimum	Maximum	
GMV-N140U/A-T	9.0	2.09	2.64	7.9	9.9	1500~1850
	11.2	2.65	3.3	10	12.3	1850~2100
	14.0	3.31	4.12	12.4	15.4	2100~2400
GMV-N280U/A-T	22.4	4.63	6.60	17.7	24.6	3700~4200
	28.0	6.61	8.25	24.7	30.8	4200~4800
GMV-N560U/A-T	45.0	10	11.8	42.5	47.5	7400~8000
	50.4	11.9	13.7	47.6	53.2	8000~5600
	56.0	13.8	15.6	53.3	58.7	8600~9200

Notes:

1. The capacity of heat exchanger is obtained at these test conditions: evaporation temperature at air outlet of heat exchanger is 6°C, overheating degree of heat exchanger is 5°C and the air return temperature is 27°CDB/19°CWB.
2. The heat exchanger of air handling unit is designed for R410A, and it's working pressure is 4.2MPa.
3. Quantity of rows of heat exchanger: no more than 4 rows.
4. The diameter of copper pipe of heat exchanger is no more than 12.7mm. 9.52mm is recommended.

 Notes: The air handling unit can be connected as a standard indoor unit to the outdoor unit.

The limitations of connection are determined by the outdoor unit.

1.4 Selecting the AHU-KIT Unit

The corresponding AHU-KIT unit needs to be selected for your air handling unit. Select the AHU-KIT unit according to the above limitations.

Capacity ranges of different AHU-KIT unit are as follows:

Model	Acquiescent capacity (kW)	Adjustable capacity (kW)
GMV-N140U/A-T	14.0	9.0/11.2/14.0
GMV-N280U/A-T	28.0	22.4/28
GMV-N560U/A-T	56.0	45/50.4/56

Different capacities of same model of AHU-KIT unit are achieved through dialing capacity code of mainboard (shown as "S1").Capacity code setting is shown as follows:

S1					Capacity (kW)
1	2	3	4	5	
0	0	1	1	0	9.0
0	1	1	1	0	11.2
0	0	0	0	1	14.0
1	1	0	0	1	22.4
1	0	1	0	1	28.0
1	0	0	1	1	45.0
0	1	0	1	1	50.4
1	1	0	1	1	56

Please ensure dialing the code switch properly in place instead of middle position. Setting the switch to "ON" stands for "0", otherwise stands for "1".

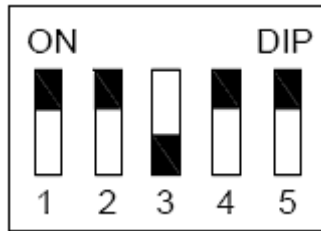

(Notes: The black part is the deflector rod.) The figure shows that the addresses of "1,2,3,4,5" are "0,0,1,0,0".

⚠ Notes:

- (1) The selected air handling unit must be designed for R410A.
- (2) Extraneous substances (including mineral oils or moisture) must be prevented from getting mixed into the system.

1.5 Location for Installation

Select an installation site where the following conditions are fulfilled and that meets your customer's approval.

- (1) The EXV box can be installed inside and outside. The control box should be installed inside.
- (2) Do not install the EXV box in or on the outdoor unit.
- (3) Do not put the option boxes in direct sunlight. Direct sunlight will increase the temperature inside the option boxes and may reduce its lifetime and influence its operation.
- (4) Choose a flat and strong mounting surface.
- (5) Make sure there is enough free space in front and in the side of the AHU-KIT unit for future maintenance.

- (6) The installation site should be far away from heat source, inflammable gas and smoke.
- (7) Keep the air handling unit, power supply wiring and transmission wiring at least 1 m away from televisions and radios. This is to prevent image interference and noise in those electrical appliances. (Noise may be generated depending on the conditions under which the electric wave is generated, even if 1 m is kept.)
- (8) Make sure the electronic expansion valve is installed in an upright position.

⚠ Notes!

- (1) Do not install or operate the unit in rooms mentioned below:
 - a)Where mineral oil, like cutting oil is present.
 - b)Where the air contains high levels of salt such as air near the ocean.
 - c)Where sulphurous gas is present such as that in areas of hot spring.
 - d)In vehicles or vessels.
 - e)Where voltage fluctuates a lot such as that in factories.
 - f) Where high concentration of vapor or spray are present.
 - g)Where machines generating electromagnetic waves are present.
 - h)Where acidic or alkaline vapor is present.
- (2) Installing this unit must comply with the relevant local and national codes.
- (3) Connecting the power after all installation works are done.

1.6 Requirements for Communication Wire

⚠ Notes:

If the unit is installed in the place with strong electromagnetic interference, shielded wire must be applied on the communication wire between indoor unit (AHU-KIT) and wired controller.

Twisted pair wire with shielding function must be applied on the communication wire between indoor unit and indoor unit (outdoor unit).

1.6.1 Selecting communication wire for AHU-KIT and wired controller

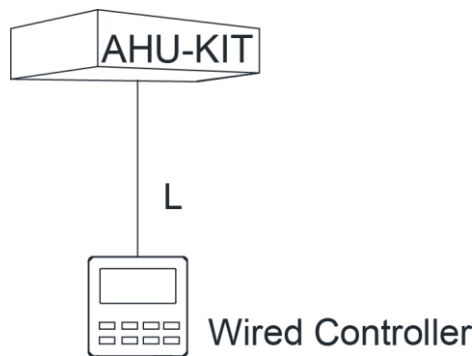
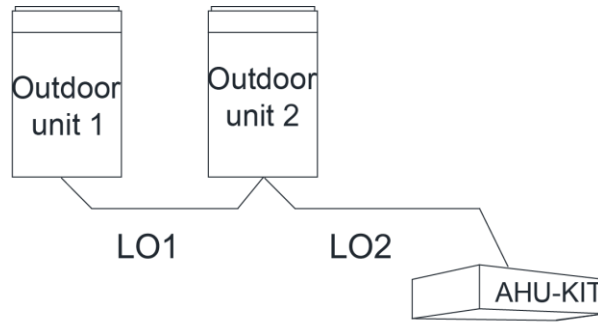

Fig.3.1

Wire Type	Total Length of Communication wire L(m)	Wire Gauge (mm ²)	Wire Standard	Remark
Light/Common PVC Jacket Soft Wire	$L \leq 250$	2×0.75 ~ 2×1.25	GB/T 5023.5-2008	The total length of communication wire should not exceed 250m.
Light shield/Common PVC Jacket Soft Wire	$L \leq 250$	2×0.75 ~ 2×1.25	GB/T 5023.5-2008	The shield cable is required when the unit is installed in the environment of strong magnetic or interference.

1.6.2 Select Communication wire for AHU-KIT and Outdoor Unit



$$L=L01+L02$$

Fig.3.2

Wire Type	Total Length of Communication wire L(m)	Wire Gauge (mm ²)	Wire Standard	Remark
Light/Common PVC Jacket Soft Wire	L ≤ 1000	≥ 2×0.75	GB/T 5023.5-2008	If wire gauge is 2X1 mm ² , then it's OK to increase the length of communication wire. But total length should not exceed 1500m.
Light shield/Common PVC Jacket Soft Wire	L ≤ 1000	≥ 2×0.75	GB/T 5023.5-2008	The shield cable is required when the unit is installed in the environment of strong magnetic or interference.

1.7 Wiring Requirements

Power Cord Size and Air Switch Capacity:

Model	Power Cord Size	Air Switch Capacity(A)	Ground Wire	Power Cord
			Minimum Sectional Area(mm ²)	Minimum Sectional Area(mm ²)
GMV-N140U/A-T	220~240V/1ph/50Hz & 208~230V/1ph/60Hz	6	1	1
GMV-N280U/A-T				
GMV-N560U/A-T				

⚠ Notes:

- (1) Use copper wire only as unit's power cord. Operating temperature should be within its rated value.
- (2) Above selection requirements: Power cord size is based on BV single-core wire (2~4pc) at 40°C ambient temperature when laying across plastic pipe (GB/T 16895.15-2002). Air switch is D type and used at 40°C. If actual installation condition varies, please lower the capacity appropriately according to the specifications of power cord and air switch provided by manufacturer.
- (3) Install cut-off device near the unit. The minimum distance between each stage of cut-off device should be 3 mm (The same for both indoor unit and outdoor unit).

2. Installation Instructions

2.1 Unit Dimensions and Maintenance Space

(1) Size of control box for GMV-N140U/A-T, GMV-N280U/A-T and GMV-N560U/A-T (Unit: mm):

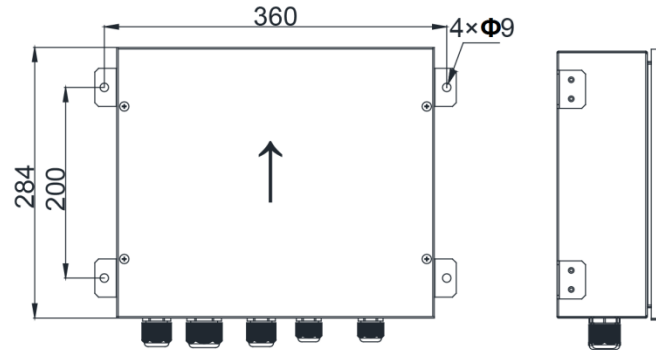

Maintenance space of control space (Unit: mm):

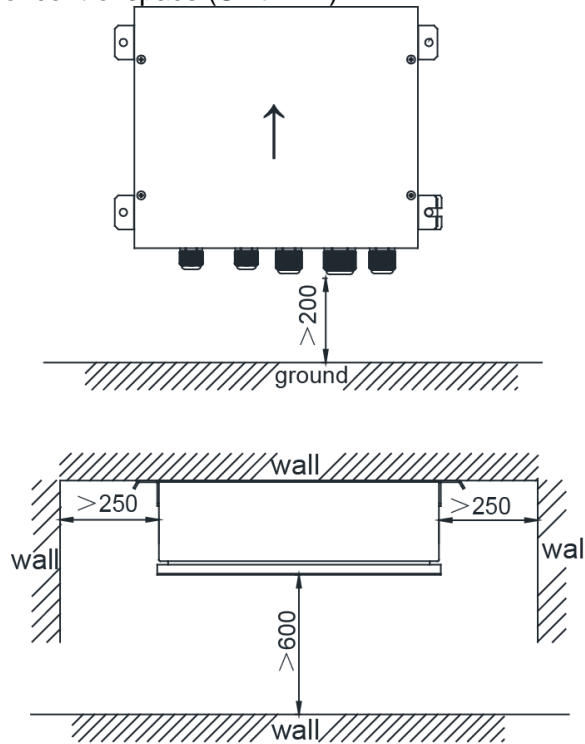

The control box must be installed upwards as the direction of the arrow shown in the figure

(2) Size of EXV box for GMV-N140U/A-T and GMV-N280U/A-T (Unit: mm):

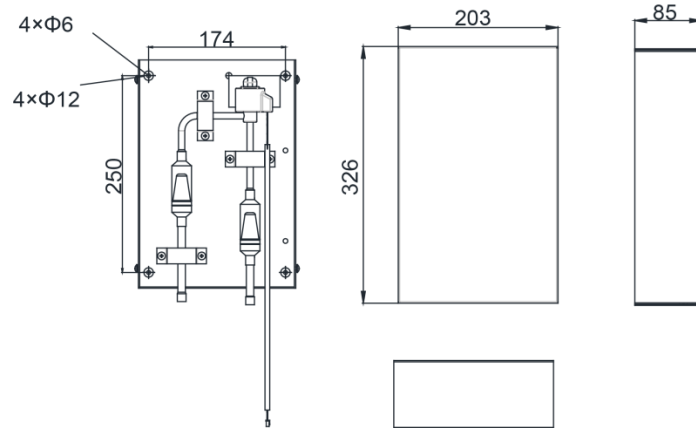

Size of EXV box for GMV-N560U/A-T (Unit: mm):

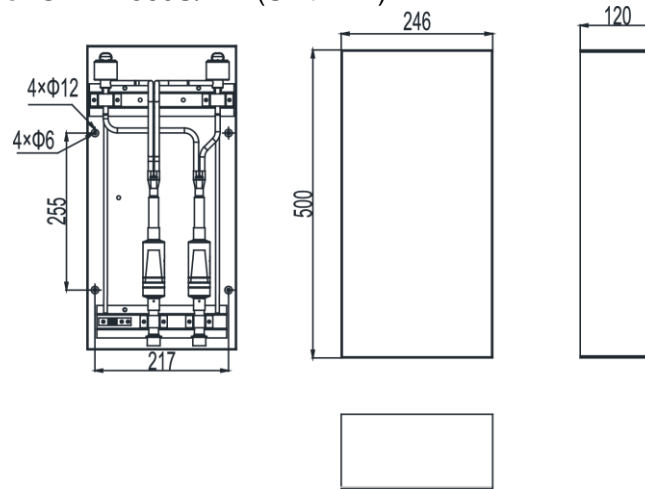

Maintenance space of EXV box (Unit: mm):

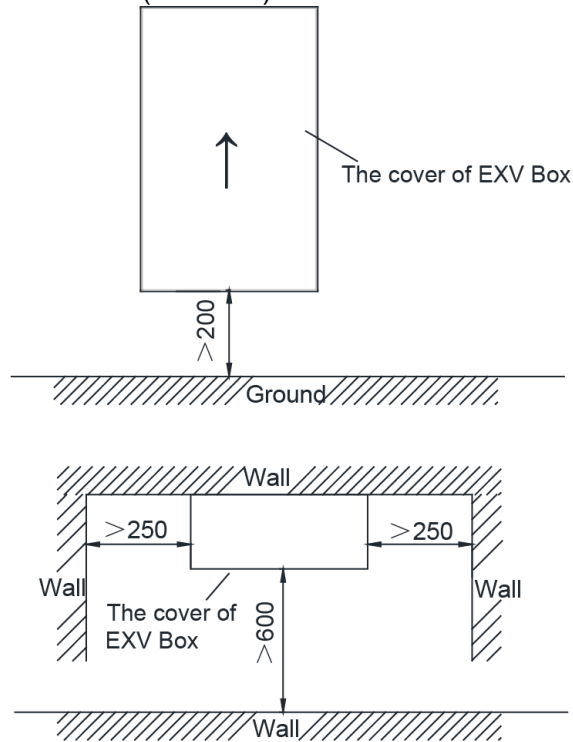

The EXV box must be installed upwards as the direction of the arrow shown in the figure

2.2 Piping Installation

2.2.1 Diagram of Piping Connection

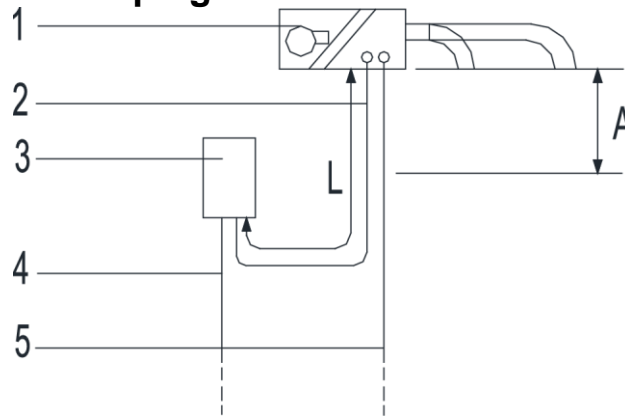

1. Air handling unit
2. Connection pipe from expansion valve kit to air handling unit
3. Valve kit
4. Liquid pipe
5. Gas pipe

△ Notes:

A: When the air handling unit is installed at the top of the EXV box, vertical distance between the bottom of the air handling unit to the EXV box is no more than 2 m; if the air handling unit is installed under the EXV box, vertical distance between the bottom of the air handling unit to the EXV box is no more than 2 m.

L: The length of liquid pipe between the air handling unit to EXV box is no more than 2 m.

L is to be considered as a part of the total maximum piping length. See installation manual of the outdoor unit for piping installation.

2.2.2 Piping Connections

Make sure to install gas and liquid pipe diameters in function of the air handling unit capacity class.

Model	Capacity(kW)	Gas pipe(mm)	Connection pipe
			Liquid pipe(mm)
GMV-N140U/A-T	9.0	Φ15.9	Φ9.52
	11.2	Φ15.9	Φ9.52
	14.0	Φ15.9	Φ9.52
GMV-N280U/A-T	22.4	Φ19.05	Φ9.52
	28.0	Φ22.2	Φ9.52
GMV-N560U/A-T	45.0	Φ28.6	Φ12.7(*)
	50.4	Φ28.6	Φ15.9
	56.0	Φ28.6	Φ15.9

(*)Note:

The internal diameter of both inlet tube and outlet tube of EXV box for GMV-N560U/A-T is Φ16.3. It needs engineering treatment on the scene if you want to connect liquid pipe of Φ12.7(expanding the copper tube of Φ12.7 or using a connection copper tube) in order to satisfy the clearance requirement of brazing(the clearance requirement is 0.1~0.2mm normally).

2.2.3 Selection of Piping

- (1) Ensure the inside of the pipes is clean and no foreign materials.

(2) Pipe specifications:

R410A System		
Pipe Φ (mm/inch)	Thickness(mm)	Temper grade of piping material
Φ6.35 (1/4)	≥0.8	O
Φ9.52 (3/8)	≥0.8	O
Φ12.70 (1/2)	≥0.8	O
Φ15.9 (5/8)	≥1.0	O
Φ19.05 (3/4)	≥1.0	O
Φ22.2 (7/8)	≥1.2	1/2H
Φ25.40 (1/1)	≥1.2	1/2H
Φ28.6 (9/8)	≥1.2	1/2H
Φ31.8 (5/4)	≥1.3	1/2H
Φ34.90 (11/8)	≥1.3	1/2H
Φ38.10 (12/8)	≥1.5	1/2H
Φ41.30 (13/8)	≥1.5	1/2H
Φ44.5 (7/4)	≥1.5	1/2H
Φ51.4 (7/4)	≥1.5	1/2H
Φ54.1 (17/8)	≥1.5	1/2H

2.2.4 Cautions for Brazing

(1) Make sure there is nitrogen protection during welding.

Brazing without carrying out nitrogen replacement or releasing nitrogen into the piping will create large quantities of oxidized film on the inside of the pipes, adversely affecting valves and compressors in the refrigerating system and preventing normal operation.

(2) When brazing while inserting nitrogen into the piping, nitrogen must be set to 0.02 MPa with a pressure-reducing valve (=just enough so that it can be felt on the skin).

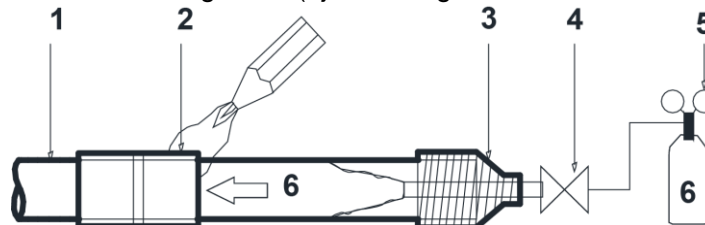

- 1. Refrigerant piping
- 2. Part to be brazed
- 3. Taping
- 4. Hands valve
- 5. Pressure-reducing valve
- 6. Nitrogen

(3) For details, see manual of the outdoor unit.

⚠ Notes:

- ① All field piping must be provided by a licensed refrigeration technician and must comply with the relevant local and national codes.
- ② The EXV box is required to be installed in a vertical direction within the range of 90±15° (not allowed for horizontal work). Welding the connection tubes first before refrigerant pipes in order to avoid face-down soldering.
 - a. For refrigerant piping of outdoor unit, refer to the installation manual supplied with the outdoor unit.
 - b. The maximum allowed piping length depends on the connected outdoor model.

2.3 EXV Installation

2.3.1 Mechanical Installation

- (1) Remove the EXV box cover by unscrewing screws.
- (2) Drill 4 holes on correct position (measurements as indicated in figure below) and fix the valve kit box securely with 4 screws through the provided holes $\text{Ø}12$ mm.

⚠ Notes:

- ① Make sure that the EXV box is installed upwards.
- ② Make sure there is enough free space in front and in the side of the box for future maintenance.

2.3.2 Welding Work

- (1) Prepare the inlet/outlet field piping just in front of the connection (do not weld yet).

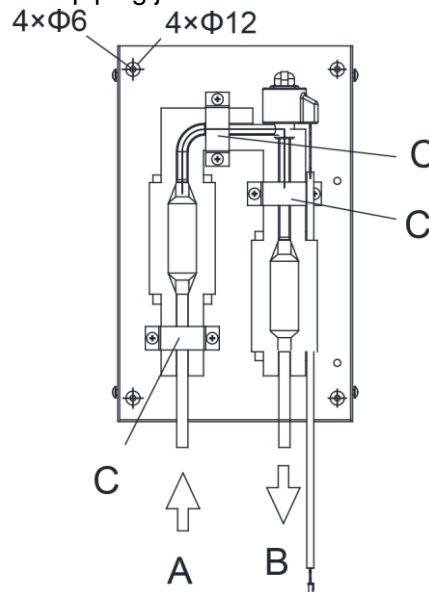

Fig.4.3.2

- A Inlet coming from the outdoor unit
 B Outlet to air handling unit
 C Wire clamp

- (2) Remove the wire clamp (C) by unscrewing 6xM4.2.
- (3) Weld the field piping.

⚠ Notes:

- ① Make sure to cool the filters and valve body with a wet cloth and make sure the body temperature does not exceed 120°C during welding.
- ② Make sure that the other parts such as electrical box, tie wraps and wires are protected from direct welding flames during welding.
- ③ The EXV box is required to be installed in a vertical direction within the range of $90\pm 15^{\circ}$ (not allowed for horizontal work). Welding the connection tubes first before refrigerant pipes in order to avoid face-down soldering.
- (4) Secure the wire clamp (C) in place again (6xM4.2).
- (5) Make sure that field pipes are fully insulated. Make sure that there is no gap between both ends in order to avoid condensation dripping (finish the connection with tape eventually).

2.4 Installation of the Control Box

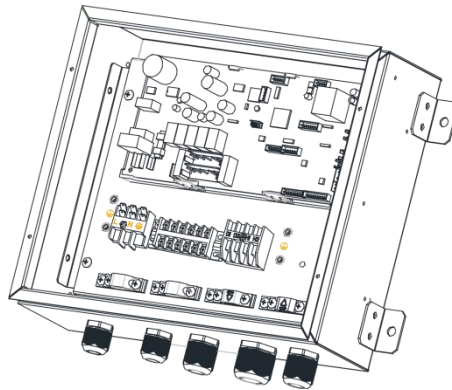

2.4.1 Mechanical Installation

- (1) Fix the control box with its hanger brackets to the mounting surface.
- (2) Open the lid of the control box.
- (3) For electrical wiring: refer to the following contents.
- (4) Install the screw nuts.
- (5) Close the unnecessary openings.
- (6) Close the lid securely after installation to ensure that the control box is watertight.

2.4.2 Wire connection Inside the Control Box

⚠ Notes:

1. Pull the wires inside through the screw nut and close the nut firmly in order to ensure a good pull relieve and water protection.
2. The cables require an additional pull relief. Fixing the cable with the wire clamp.

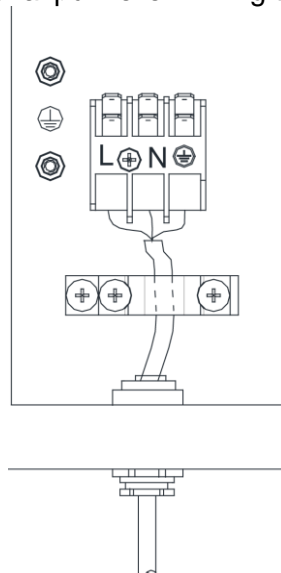

Precautions:

Thermistor cable and remote controller wire should be kept away from power cable in a distance of at least 50mm. Violating this rule may generate electric noise and lead to malfunctions.

Use wires as specified and connect them tightly with wiring terminals. Keep the wires in order and do not obstruct other devices. Insecure connection may result in overheating or even cause electric shock or fire hazard.

Wiring connection:

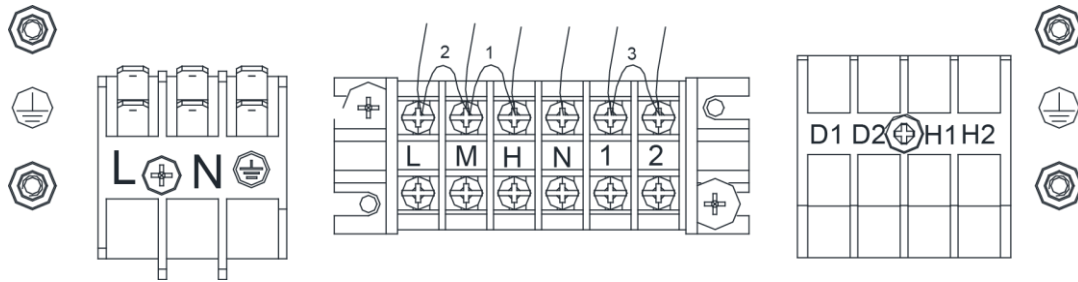

Connecting cables according to the following instructions, as figure shown above.

L..... Live

N..... Neutral

..... Protective earth (screw)

H.....High gear of fan

M.....Middle gear of fan

L..... Low gear of fan

1/2..... Lines of fault signal from external feedback

D1/D2.....Communication wires

H1/H2.....Wired controller

 Notes:

- ① The H, M, L of fan gear lines and the 1, 2 of Lines of fault signal from external feedback are shorted by the factory default.
- ② Neutral line of fan connects to the N.
It can be connected to any of them (H, M, L) when there is only one gear.
Disconnect the short cable between H and M when there are two gears, then connect the high gear cable to H, and connect low gear cable to either M or L.
When there are three gears, disconnect the short cables between H and M, M and L, then connect the high gear cable, middle gear cable and low gear cable to H,M,L for each.
- ③ The lines of fault signal from external feedback are connected to the 1, 2.The line is a dry contact and closed normally. If the line is closed, it represents no fault and the system operates normally; if the line is disconnected, it represents malfunction and the system will stop.
- ④ Disconnect the short cable between 1 and 2 when there is fault signal, and connect the signal cable to 1 and 2.
- ⑤ Pull the wires inside through the screw nut and close the nut firmly in order to ensure a good pull relieve and water protection.
- ⑥ The cables require an additional pull relief. Fixing the cable with the wire clamp.

2.5 Installation of the Thermistors

2.5.1 Refrigerant Thermistors

Location of the thermistor:

A correct installation of the thermistors is required to ensure a good operation:

- (1) Liquid(RT2)

Install the thermistor behind the distributor on the coldest pass of the heat exchanger (contact your heat exchanger dealer).

- (2) Gas (RT4)

Install the thermistor at the outlet of the heat exchanger as close as possible to the heat exchanger.

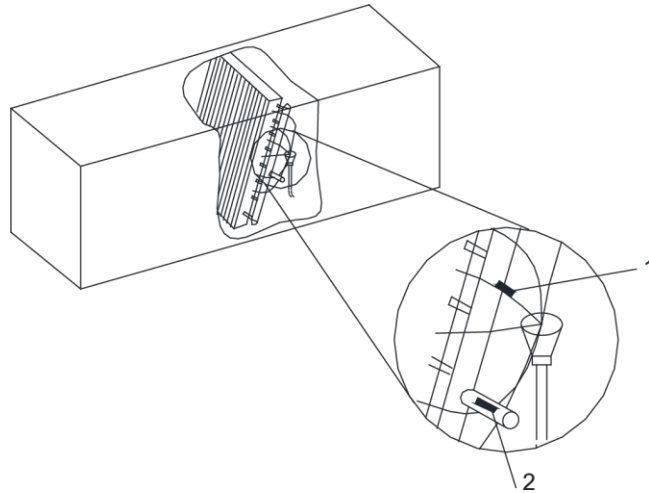

- 1. Liquid RT2
- 2. Gas RT4

Installation of the thermistor cable

- (1) The length of thermistor wire is 10 m.
- (2) Put the thermistor cable in an individual protective tube.
- (3) Apply stress release in the temperature sensor wire to prevent the temperature sensor wire from getting loose due to stress. Stress or looseness of temperature sensor wire will lead to poor contact and inaccuracy of temperature measuring.

Fixation of the thermistor

⚠ Notes:

Put the thermistor wire slightly down to avoid water accumulation on top of the thermistor.

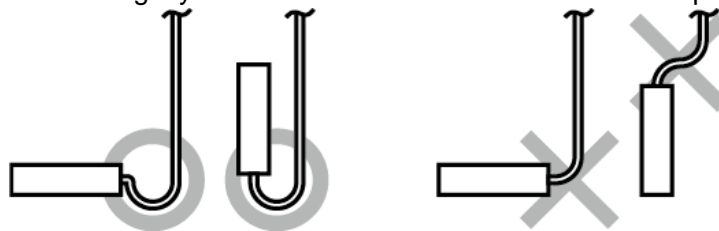

Keep the thermistor and air handling unit in good contact. Put the top of the thermistor on the air handling unit, because the top of thermistor is the most sensitive part. Please fixing the thermistor on the horizontal plane of copper tube (within $\pm 30^\circ$), and make them close together.

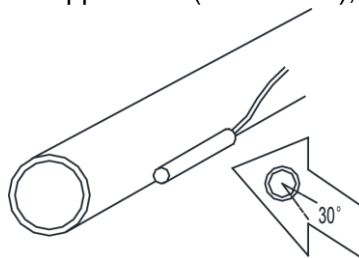

- (1) Fix the thermistor with insulating aluminum tape in order to ensure good heat transference.

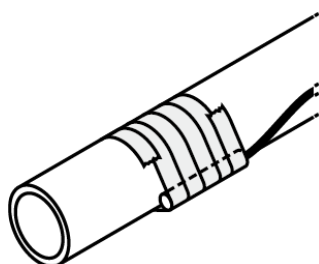

- (2) Cover the thermistor with rubber belt to prevent looseness of temperature sensor.

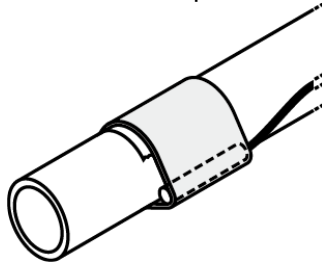

- (3) Use two wire ties to bind the thermistor securely.

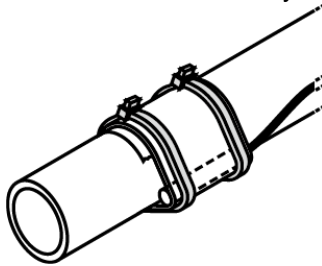

- (4) Wrap the thermistor with insulating trip.

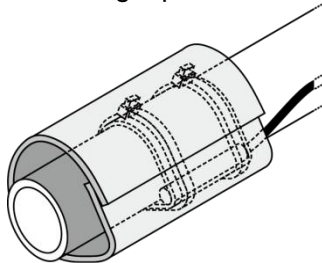

2.5.2 Air Thermistor

The air thermistor (RT1) can be installed in the space which needs temperature control, or the inlet scoop of air handling unit.

⚠ Notes:

- (1) For connection to outdoor unit and to AHU-KIT unit: Pull the wires inside through the screw nut and close the nut firmly in order to ensure a good pull relieve and water protection.
- (2) The cables require an additional pull relief. Fixing the cable with the wire clamp.
- (3) The connection of thermistor requires enough space.

2.6 Installation of the EXV Cable

Referring to the circuit diagram, then connect the EXV cable to the circuit-board of control box. Be sure that the cable is fixed firmly in order to ensure a good pull relieve and water protection.

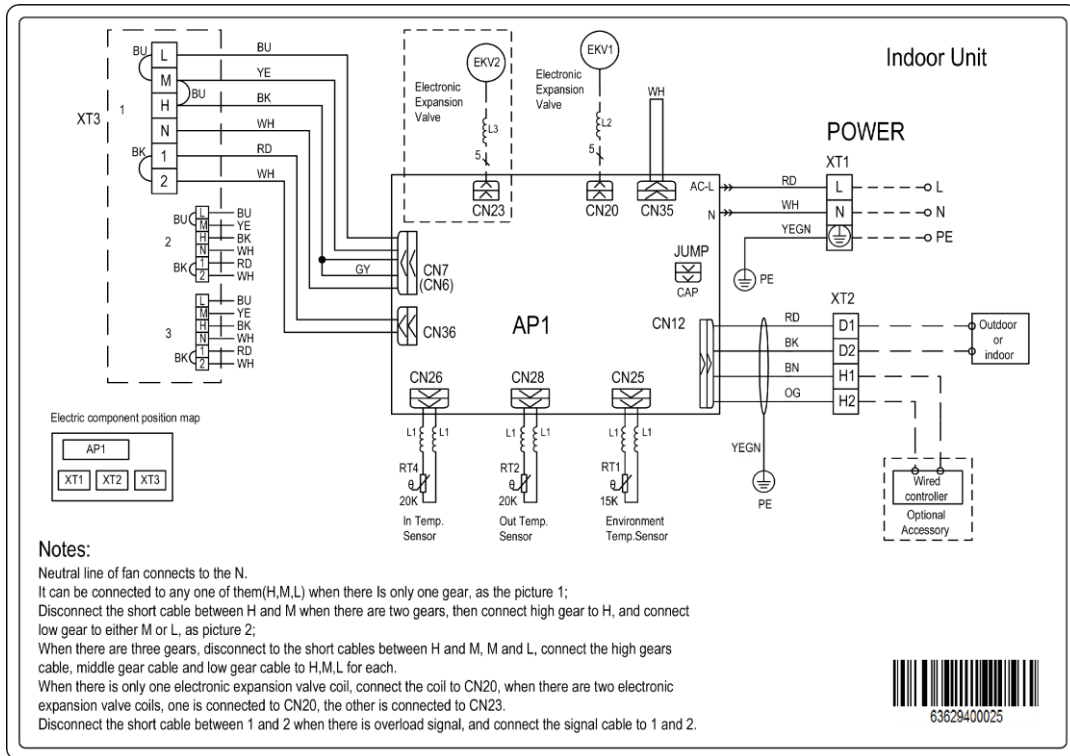

2.7 Installation of Wired Controller

Please refer to User Manual of Wired Controller for the installation details.

⚠ Notes:

When installation is finished, the unit must be tested and debugged before operation. Please refer to Instruction Manual of ODU for auto addressing and debugging details.

3. Wire Connection

⚠ Notes:

- (1) Units must be earthed securely, or it may cause electric shock.
- (2) Please carefully read the wiring diagram before carry out the wiring work, incorrect wiring could cause malfunction or even damage the unit.
- (3) The capacity of power supply should be big enough.
- (4) The unit should be powered by independent circuit and specific socket.
- (5) The wiring should be in accordance with related regulations in order to ensure the units reliable running.
- (6) Install circuit breaker for branch circuit according to related regulations and electrical standards.
- (7) All wiring must use pressure terminal or single wire. Multi-twisted wire that connects directly to the wiring board may cause fire hazard.
- (8) Keep cable away from refrigerant piping, compressor and fan motor.
- (9) Do not alter the inner wires of air conditioner. Manufacturer does not assume responsibility for damage or abnormal operation due to this reason.
- (10) If the unit is installed in places with strong electromagnetic interference, it's recommended to use twin-twisted shield wire. During wire connection, please pay attention that the metal shield layer of the twin-twisted wire must be grounded(outer case) in order to prevent the unit from electromagnetic interference.
- (11) The communication wires should be separated from power cord and connection wire between indoor unit and outdoor unit.
- (12) The appliance shall be installed in accordance with national wiring regulations.

3.1 Connect Cables and Terminals of Wiring Board

- (1) Connection of Wire and Patch Board Terminal (as shown in fig.5.1.1)
 - 1) Strip about 25mm insulation of the wire end by stripping and cutting tool.
 - 2) Remove the wiring screws on the terminal board.
 - 3) Shape the tail of wire into ring by needle nose plier, and keep the gauge of ring in accordance with screw.
 - 4) Use the screwdriver for tightening the terminal.
- (2) The connection of stranded wire (as shown in fig.5.1.2)
 - 1) Strip about 10mm insulation of the end of stranded wire by stripping and cutting tool.
 - 2) Loosen the wiring screws on terminal board.
 - 3) Insert the wire into the ring tongue terminal and tighten by crimping tool.
 - 4) Use the screwdriver for tightening the terminal.

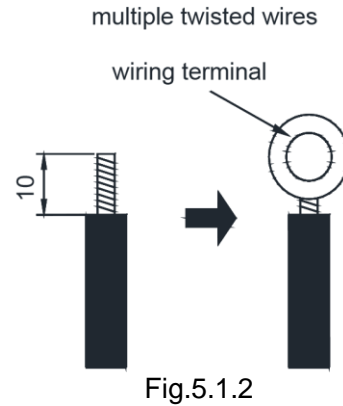
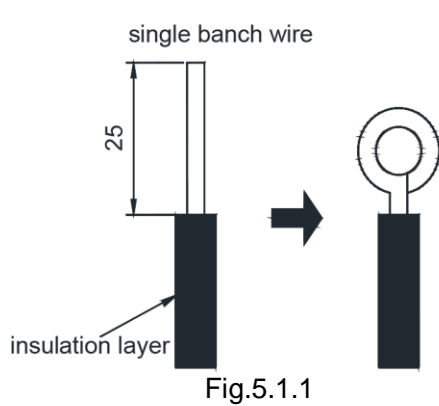

3.2 Power Cord Connection

⚠ Notes!

Power supply of each indoor unit must be from the same source.

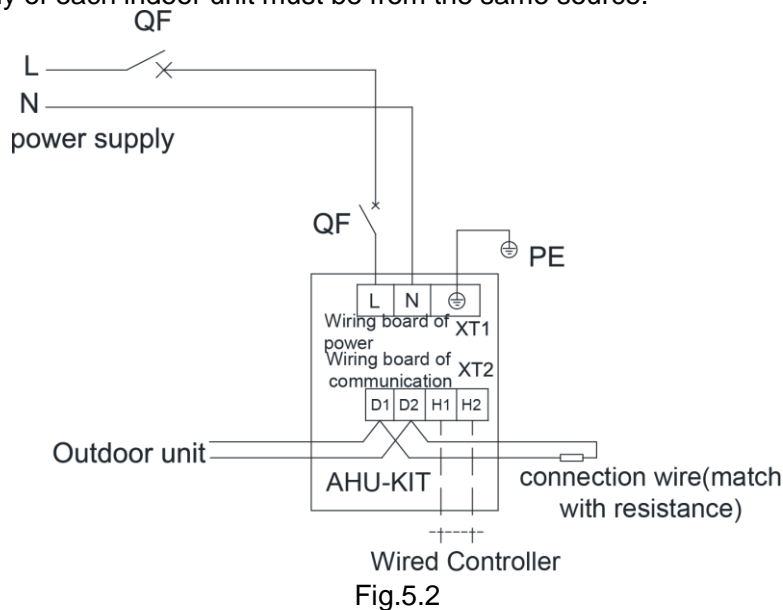

For units with single-phase power supply:

- 1) Detach the electric box lid.
- 2) Let the power cord pass through the wiring through-holes.
- 3) Connect the power cord to terminal “L, N, 

3.3 Connection of Communication Wire between Indoor Unit and Outdoor Unit (or Indoor Unit)

- 1) Detach the control box lid.
- 2) Let the Communication cable pass through the wiring through-holes.
- 3) Connect the communication wire to terminal D1 and D2 of indoor 4-bit wiring board, as shown in fig.5.3.1.
- 4) Fix the communication cable with clamp of electric box.
- 5) For more reliable communication, make sure connect the terminal resistor to the most downstream IDU of the communication bus (terminal D1 and D2), as shown in fig 5.3.2, terminal resistor is provided with each ODU.

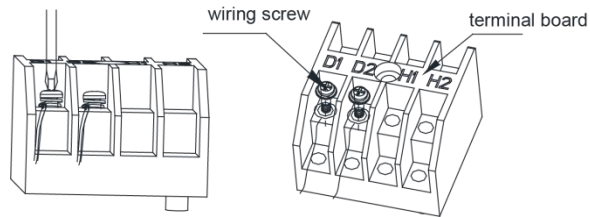

Fig.5.3.1

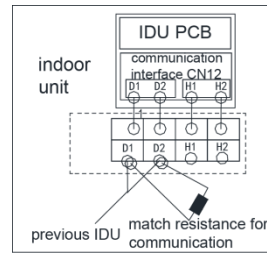

Fig.5.3.2

3.4 Connect Communication Wire of Wired Controller

- 1) Open electric box cover of indoor unit.
- 2) Let the communication wire go through the rubber ring.
- 3) Connect the communication wire to terminal H1 and H2 of indoor 4-bit wiring board.
- 4) Fix the communication wire with wire clip on the electric box.
- 5) Wiring instructions of remote receiving light board and wired controller:
Fig.5.4 shows the installation of wired controller:

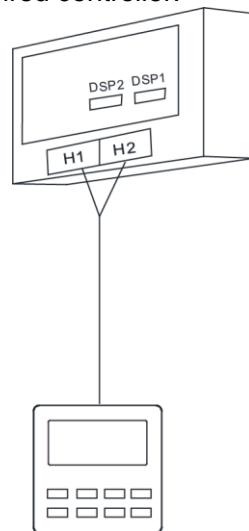

Fig.5.4

3.5 Illustrate for Connection of Wired Controller and Indoor Units (AHU-KIT) Network

- (1) Communication wire of indoor unit and outdoor unit (or indoor unit) is connected to D1, D2.
- (2) Wired controller is connected to H1, H2.
- (3) One indoor unit can connect two wired controllers that must be set as master one and slave one.
- (4) One wired controller can control 16 indoor units in maximum at the same time (as shown in fig.5.5).

⚠ Notes:

- 1) The type of indoor units must be the same if they are controlled by the same wired controller.
- 2) When the indoor unit is controlled by two wired controllers, the addresses of the two wired controllers should be different through address setting. Address 1 is for main controller; Address 2 is for slave controller. Detailed settings please refer to the instruction manual of wired controller.

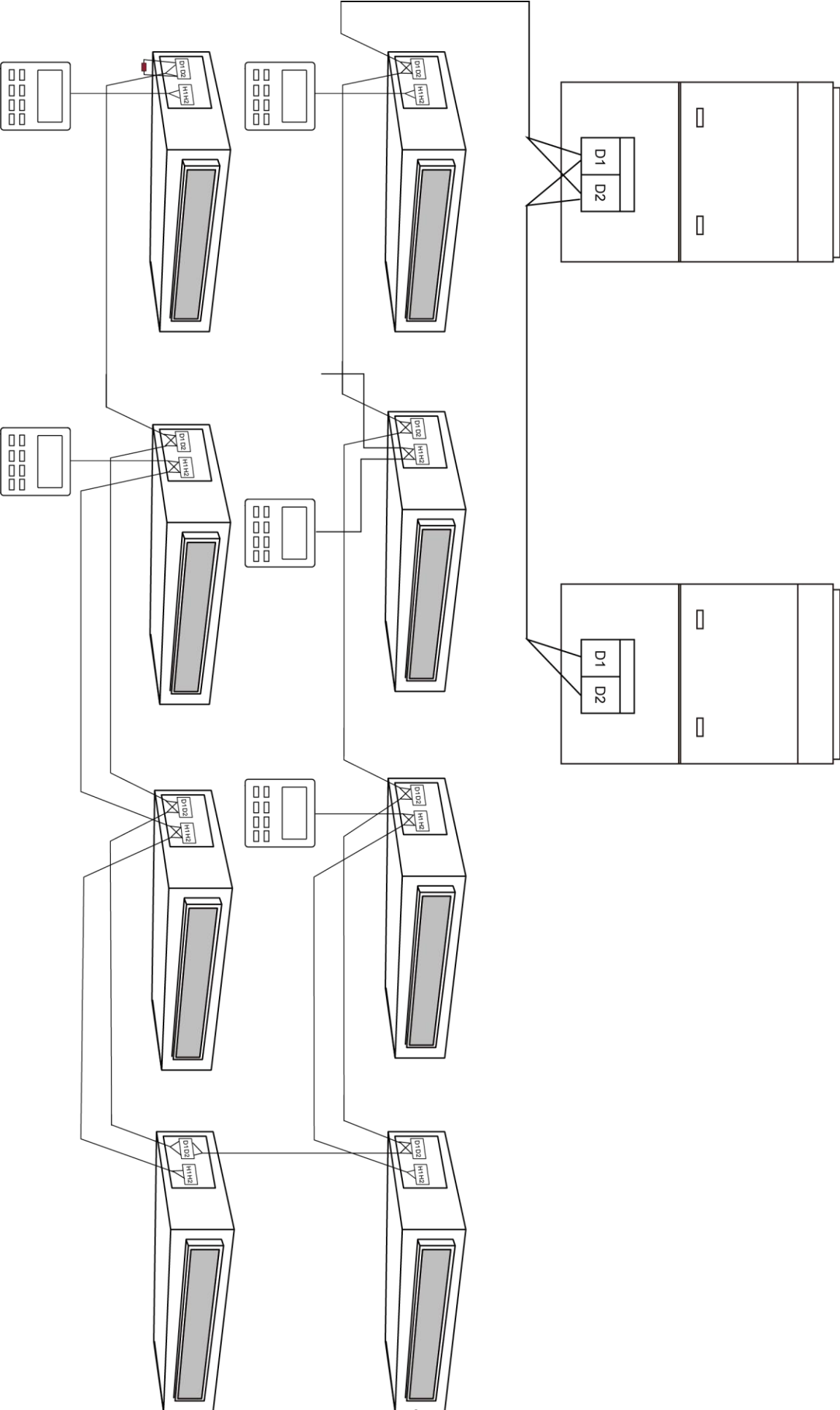

Chapter Four: Debugging Operation

1. Before Operation

⚠ Notes:

- Before initiating operation, please read the operation manuals of outdoor unit, AHU-KIT unit and the air handling unit carefully.
- Refer to the installation manuals of the outdoor unit, AHU-KIT unit and the remote controller about settings of unit.

2. Test Operation

Before executing "test operation" as well as before operating the unit, you must check the following:

- (1) Refer to the section of "For the following items, take special care during construction and check after installation is finished".
- (2) Ensure the construction of refrigerant piping, drain piping and electric wiring are finished.
- (3) Check everything written in the installation manuals of the outdoor unit, AHU-KIT unit and the air handling unit.
- (4) Open the gas side stop valve.
- (5) Open the liquid side stop valve.

Executing the test operation:

- (1) Referring to the manuals of the outdoor unit and the air handling unit.
- (2) Confirm that the fan of the air handling unit is ON.

⚠ Notes:

In case of poor distribution in the air handling unit, 1 or more passes of the air handling unit may freeze-up (collect ice) → put the thermistor (RT4) on this position.

Chapter Five: Maintenance Part

1. Table of Error Codes for Indoor Unit

Error Code	Content	Error Code	Content	Error Code	Content
L0	Indoor Unit Error	L9	Quantity Of Group Control Indoor Units Setting Error	d8	Water Temperature Sensor Error
L1	Error From External Feedback	LA	Indoor Units Incompatibility Error	d9	Jumper Cap Error
L2	E-heater Protection	LH	Low Air Quality Warning	dA	Indoor Unit Hardware Address Error
L3	Water Full Protection	LC	Outdoor-Indoor Incompatibility Error	dH	Wired Controller PC-Board Error
L4	Wired Controller Power Supply Error	d1	Indoor Unit PC-Board Error	dC	Capacity DIP Switch Setting Error
L5	Anti-Frosting Protection	d3	Ambient Temperature Sensor Error	dL	Outlet Air Temperature Sensor Error
L6	Model Conflict	d4	Inlet Piping Temperature Sensor Error	dE	Indoor Unit CO ₂ Sensor Error
L7	No Master Indoor Unit Error	d6	Outlet Piping Temperature Sensor Error	C0	Communication Error
L8	Power Insufficiency Protection	d7	Humidity Sensor Error	AJ	Filter Cleaning Reminder
db	Special Code: Field Debugging Code				

2. Troubleshooting

If your air conditioner is not working well, please check the following table first before asking for service:

Phenomenon	Troubleshooting
The unit can't start	<ul style="list-style-type: none"> ① No power supply. ② Circuit breaker is tripped because of current leakage. ③ Circuit voltage is too low. ④ ON/OFF key sets at the stop position. ⑤ Failure in control system.
The unit stops after running for a while	<ul style="list-style-type: none"> ① Obstacle in front of the condenser. ② Abnormal operation of the control system. ③ Outdoor temperature is higher than 43°C when cooling mode is used.
Poor cooling effect	<ul style="list-style-type: none"> ① Air filter is dirty or blocked. ② Too many heating sources or people in the room. ③ Doors or windows are open. ④ Obstacle at the air intake and outlet of the unit. ⑤ Setting temperature is too high or refrigerant is insufficient (e.g. refrigerant leakage). ⑥ Poor performance of the indoor temperature sensor.
Poor heating effect	<ul style="list-style-type: none"> ① Air filter is dirty or blocked. ② Doors or windows are open. ③ Wrong temperature setting (too low). ④ Refrigerant leakage. ⑤ Outdoor temperature is lower than -5°C. ⑥ Abnormal operation of the control system.
Indoor fan doesn't start up during heating	<ul style="list-style-type: none"> ① Improper location of tube sensor. ② The tube sensor inserts not well. ③ The wiring of tube sensor is broken. ④ Electricity leakage of capacitor.

 Notes:

If air conditioner still fails to work normally after checking and handling as described above, please stop using it immediately and contact local service center for assistance.

3. Routine Maintenance

⚠ Warning!

- (1) Only a qualified service person is allowed to perform maintenance.
- (2) Before obtaining access to terminal devices, all power supply circuits must be interrupted.
- (3) Water or detergent may deteriorate the insulation of electronic components and result in burn-out of these components.
- (4) Stand at solid table when cleaning the unit.
- (5) Do not clean the unit with hot water whose temperature is higher than 45°C to prevent fade or deformation.
- (6) Clean the filter with a wet cloth dipped in neutral detergent.
- (7) Please contact after-sales service staff if there is abnormal situation.

3.1 Maintenance Before the Seasonal Use

- (1) Check if the air inlet and air outlet of indoor and outdoor unit are blocked.
- (2) Check if securely grounded.
- (3) Check if all the power cord and communication cable are securely connected.
- (4) Check if any error code displayed after energized.

3.2 Maintenance After the Seasonal Use

- (1) Set the unit in fan mode for half a day in a sunny day to dry the inner part of unit.
- (2) When the unit won't be used for a long time, please cut off power supply for energy saving; the characters on the wired controller screen will disappear after cutting off the power supply.

3.3 Disposal Requirements

Dismantling of the unit, treatment of the refrigerant, of oil and of other parts must be done in accordance with relevant local and national legislation.



JF00302619

GREE ELECTRIC APPLIANCES, INC. OF ZHUHAI

Add: West Jinji Rd, Qianshan, Zhuhai, Guangdong, China, 519070

Tel: (+86-756) 8522218 Fax: (+86-756) 8669426

E-mail: gree@gree.com.cn www.gree.com

For continuous improvement in the products, Gree reserves the right to modify the product specification and appearance in this manual without notice and without incurring any obligations.